

MAGNETIC PARTICLE INSPECTION

**REFERENCE
GUIDE**

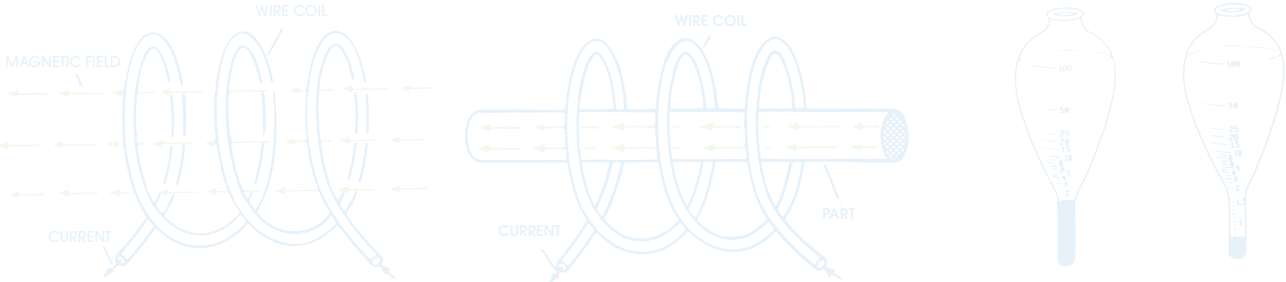

MAGNETIC PARTICLE INSPECTION

For Magnetic Particle Testing to Find Defects in Magnetic Parts

This reference guide will provide you with a general overview of performing Non-destructive Testing by the magnetic particle method. The use of this method results in finding defects which are not otherwise visible to the eye. By using Magnaflux equipment, materials, and accessories you are able to locate such inherent and processing defects as: inclusions, seams, laminations, shrinks, cracks, hot tears, laps, flakes, welding defects, heat treat and grinding cracks, machining tears, quenching and straightening cracks and also fatigue or service cracks on parts from service.

This inspection is important to the quality of the finished product, and in finding defects as early as possible in manufacturing, to avoid wasting machining and processing time on defective material.

This reference guide or parts thereof may not be reproduced in any form without written permission from Magnaflux.

For full information, refer to "Principles of Magnetic Particle Testing" by C.E. Betz (which can be purchased from Magnaflux)



How Magnetic Particle Inspection Works

Open Magnet

1. An open magnet has two poles: North and South. The magnetic field between the two poles will attract and hold a nail.

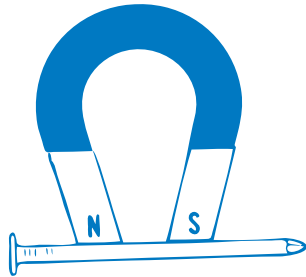

Partially Closed Magnet

2. Bend the ends of the open magnet until they almost touch and the magnetic field between the poles will hold iron powder.

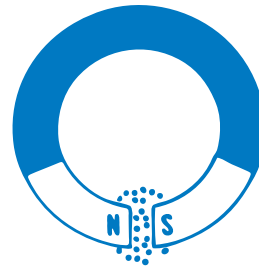

3. Bend the magnet until it is completely closed and fuse the ends. Now the magnet will not attract or hold iron powder because there is no polarity and the magnetic field is in a circle inside the ring. **This is circular magnetization.**

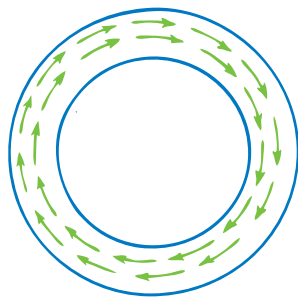

4. A crack part way through the magnet will cause polarity and a magnetic field at the crack, which will hold iron powder and build up an indication of the crack. **This is the principle of producing indications by means of circular magnetization.**

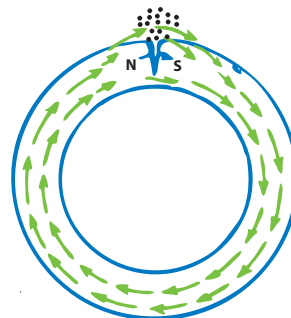

How Magnaflux® Equipment Uses Electricity to Provide Circular Magnetization For Locating Lengthwise Cracks

1. Electric current passing through a wire creates a magnetic field around the wire. Direction of the field is at 90° to the direction of the current.

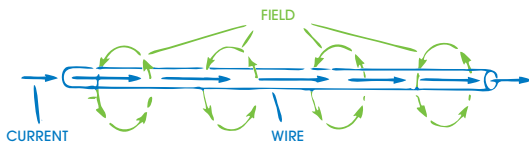

2. Electric current passing through a ferrous part creates a magnetic field within the part. This is circular magnetization—used to detect lengthwise cracks.

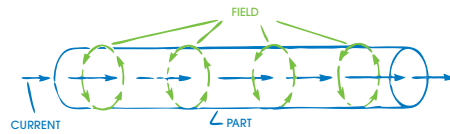

In magnetic particle inspection, circular magnetization is used to detect lengthwise cracks.

3. Part to be inspected is “set up” in the Magnaflux® unit and electric current is passed through the part or through an electrical conductor within the part. The circular magnetic field cutting across the crack attracts and holds iron powder, to indicate the invisible defects.

Electricity is passed thru the part parallel to the defects to be found.

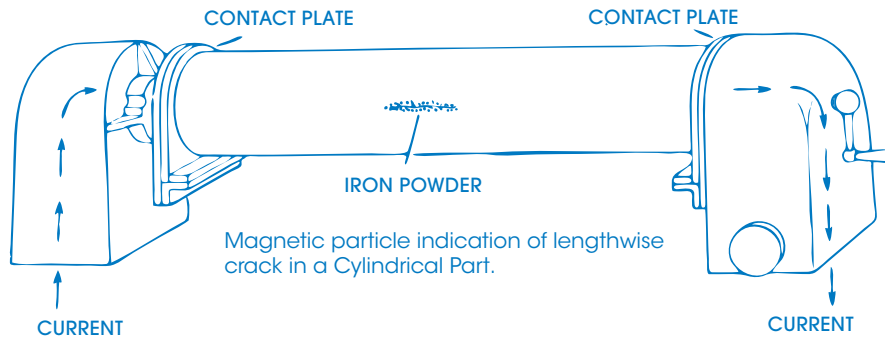

How Magnaflux® Equipment Uses Electricity to Provide Longitudinal Magnetization for Locating Transverse Cracks

1. Electric Current passing through a wire wound into a coil creates a magnetic field lengthwise inside the coil.

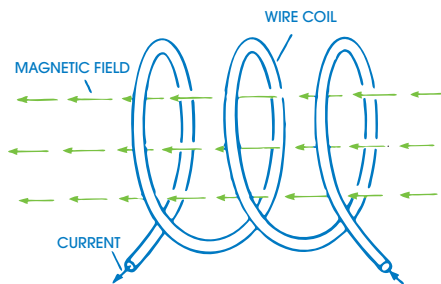

2. When a part is placed in a Magnaflux® Unit inside a coil carrying electric current, a magnetic field running lengthwise of the part is created. This is Longitudinal Magnetization.

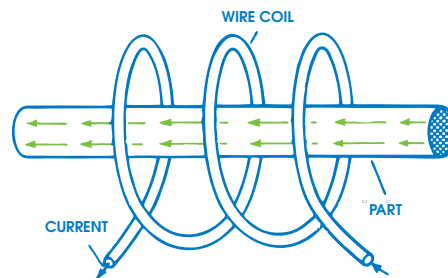

In Inspection Longitudinal Magnetization is Used to Detect Transverse (crosswise) Cracks.

3. Part to be inspected is "set up" in the Magnaflux® Unit and electric current is passed through a coil around the part. Small parts should not be centered within the coil, but held close to it where field strength is strongest. The longitudinal magnetic field cutting across the crack attracts and holds iron powder to indicate the crack.

Electric current is passed around the part, parallel to the defects to be found.

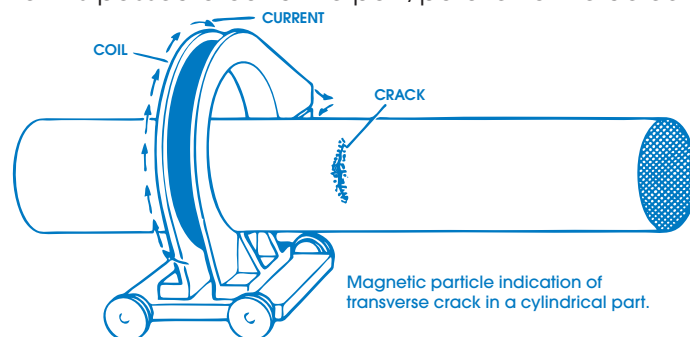

Magnetic particle recommended usage concentrations

Figure 1

PRODUCT	FORM	RECOMMENDED CONCENTRATION	SUSPENSION MEDIUM
14A	Powder	1/6 oz/gal 1.25 g/l	Water* Oil
14A Redi-Bath	Liquid Concentrate	2.7 oz/gal 21 ml/l	Water Only
20B	Preblended Powder	1.5 oz/gal 11.25 g/l	Water Only
14AM	Ready to use Premixed Bath or Aerosol	Ready to Use	Oil
MG-410	Powder	1/10 oz/gal 0.75 g/l	Water* Oil
7C Black	Powder	1.25 oz/gal 9.36 g/l	Water* Oil
7HF Black	Ready to use Aerosol	Ready to use	Oil

* Use of water conditioner is necessary to disperse the magnetic particle powder in water.

The recommended settling time in a settling tube is 60 minutes for oil baths and 30 minutes for water baths.

The recommended particle concentration for fluorescent magnetic particles is 0.1 to 0.4 ml in a 100 ml bath sample (settling tube).

The recommended particle concentration for nonfluorescent magnetic particles is 1.2 to 2.4 ml in a 100 ml bath sample (settling tube).



Preparing the Oil Bath

Applicable To: Magnaglo, 14A, MG-410, Magnavis[®], 7C.

Electric Current + Bath + Discontinuity = Magnetic Particle Indication

1. Verify that unit is clean. Clean if necessary.
2. Pour selected Carrier II oil into the tank. Note the number of gallons.
3. Weigh or measure magnetic particles as recommended on page 6 (see Figure 1).
4. Add magnetic particles to the tank.
5. Run agitator pump for a few minutes. Then test for proper bath particle concentration and adjust as necessary using centrifuge tube (see page 9).

Magnetic particles + Carrier II oil = Suspension (bath)

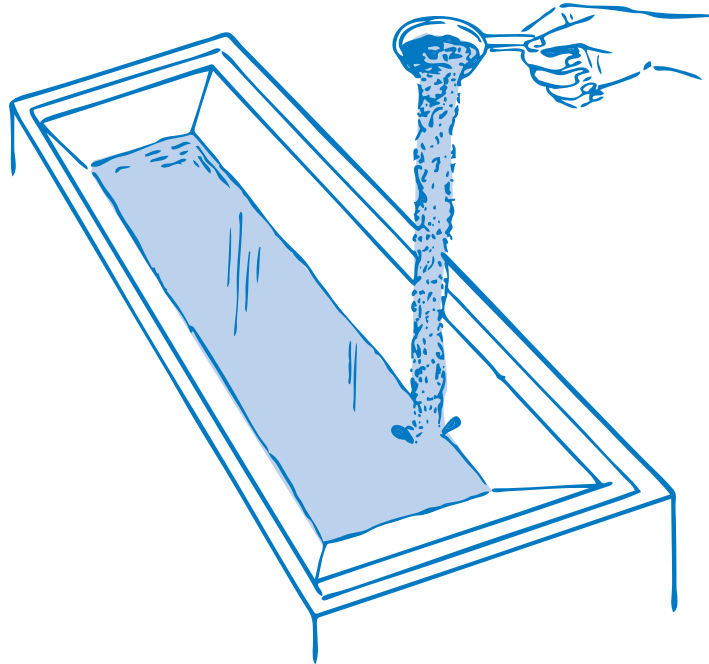

Preparing the Water Bath

Applicable To: Magnaglo[®], 14A, 20B, 14A Redi-Bath, MG410, MagnaVis[®], 7C

1. Clean unit.
2. Pour required amount of water into tank.
3. (a) For 14A, MG-410, or 7C Black, weigh or measure the WA-2B wetting agent into a container.
(b) Usable range is 1 to 1³/₄ ounces per gallon of bath.
(c) Turn on pump of Magnaflex[®] unit. Pour the wetting agent into the water directly over the sump.
4. (a) Weigh or measure MagnaVis[®] or Magnaglo particles into a separate container.
(b) Use amount specified in Figure 1 (see page 6).
5. (a) 20B or 14A Redi-Bath preblended concentrate may be poured directly into bath.
(b) Continue to run pump motor for a few minutes.
(c) Test for proper particle concentration using centrifuge tube (see page 9) and adjust as necessary.

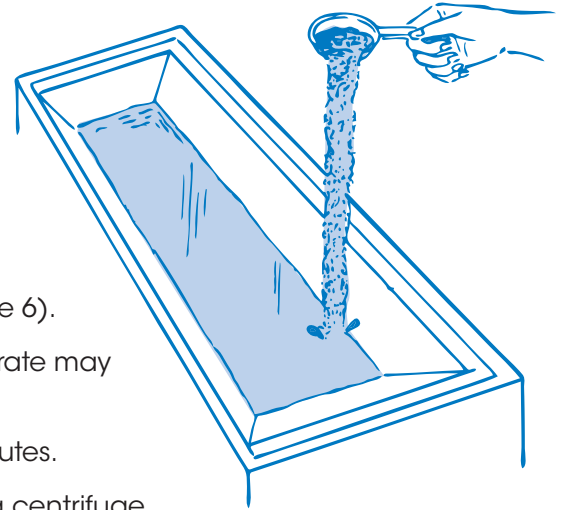

Note: The WA-2B water conditioner must be in the water before adding the magnetic particles, unless a preblended concentrate such as 20B or 14A Redi-Bath is being used.

Keep Dirt out of magnetic particle bath!

Water + WA-2B + Magnetic particle = Suspension (bath)

Water + Preblended concentrate = Suspension (bath)

Checking Particle Concentration

DO THIS ON NEWLY MIXED BATH AND DAILY THEREAFTER!

1. Let pump motor run for several minutes to agitate a normal mixture of particles and liquid.
2. Flow the bath mixture through hose and nozzle for a few moments to clear hose.
3. Fill the centrifuge tube to the 100 ml line.
4. Place centrifuge tube in stand in location free from vibration.
5. Let tube stand for 60 minutes for oil baths and 30 minutes for water baths.
 - The recommended particle concentration for fluorescent magnetic particles is 0.1 to 0.4 ml in a 100 ml bath sample (settling tube.)
 - The recommended particle concentration for nonfluorescent magnetic particles is 1.2 to 2.4 ml in a 100 ml bath sample (settling tube.)
6. If reading is higher, add proper liquid. If lower, add concentrate.

Note:

- Do not include dirt particles in your centrifuge Tube readings.
- It's a good idea to check particle concentration once a day.

Change the bath regularly—about once a week—or up to once a month if bath is not contaminated or if inspection volume is low.

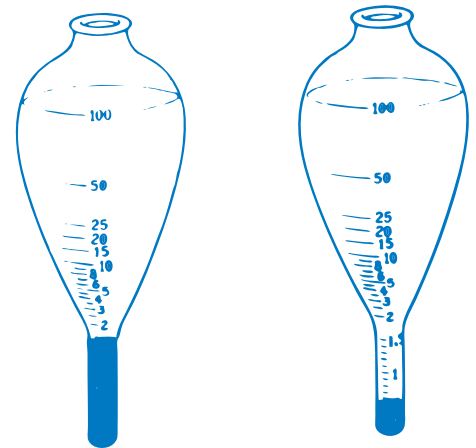
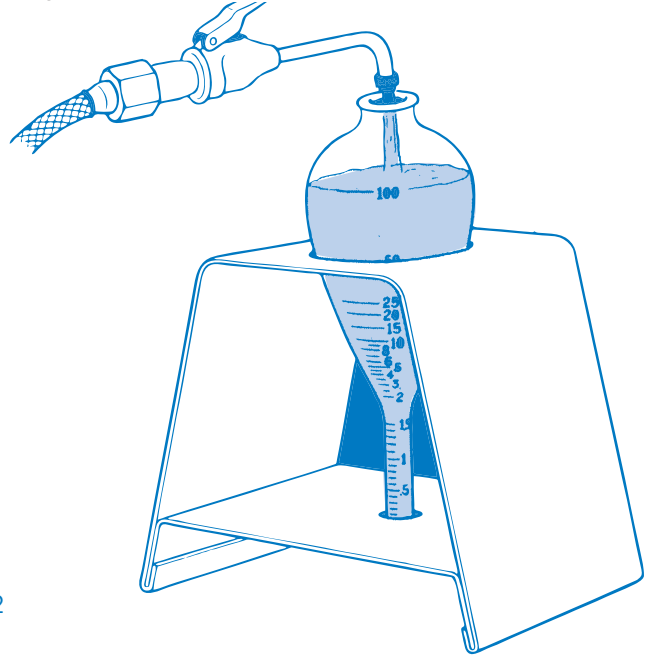

Applying the Bath

Electric Current + Bath + Defect = Magnetic Particle Indications

There are two methods for applying the bath:

A. Continuous Method—Current and bath applied together; in other words, the magnetic particles are on the part while magnetizing current is being applied.

1. Flow bath through nozzle over the part.
2. Stop the flow by releasing the nozzle.
3. Close the current switch to apply current at the same instant you release the nozzle.
4. Current passes immediately through the part while bath particles are still draining heavily over the surface.

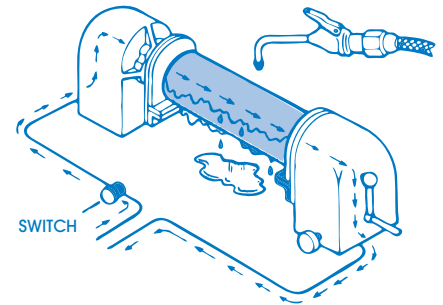

Be sure the current strength is high enough to show expected defects, but not so high that particles build up along flow lines or at any change of section.

B. Residual Method—Bath is applied after current has been shut off; that is the magnetic particles are on the part when residual (remaining) magnetic field is present.

1. Pass current through part or through coil to magnetize the part.
2. Shut off current. This will leave a residual magnetic field in parts of hard (retentive) steel.
3. Apply the bath using the hose, or by dipping the part in a separate tank of agitated bath.

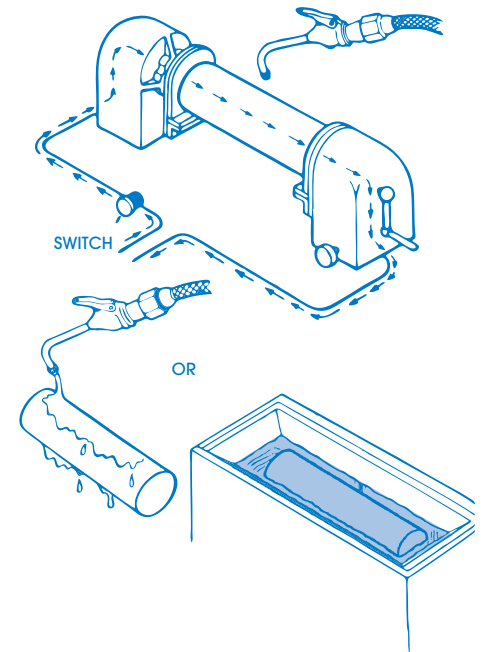

Note: The Residual Method can be only used on hard steels—which “hold” a magnetic field- usually high carbon or alloy steels, especially in the hard state.

For full information, see chapter 14 “Principles of Magnetic Particle Testing.”

Demagnetization of Parts

After Inspection, Parts are usually Demagnetized.

Alternating current coil is usually used on A.C. units. Use of the coil is preferred over using contacts. On D.C. units, use either an external demagnetizer (type S or SB coil) or the A.C. or D.C. demagnetizer built into some units.

A. Coil Demagnetization

1. Put part in coil.
2. Turn on Current.
3. Draw part out at least 3 feet away from coil while current is on. For greater effect (if needed) rotate part end-for-end while withdrawing.
4. Check for residual magnetism with a Magnaflux field indicator. Needle deflection should be slight (usually less than 3 Gauss.)

Caution: Do not turn off the current until the part is out of the magnetic influence of the coil or demagnetization will not be complete.

B. Theory: Demagnetization is accomplished by a reversing polarity field in the part. This field is progressively reduced from high to low strength in small steps.

Drawing the part out of the high strength A.C. field in the coil above results in less and less field with each current cycle (at 60 cycles per second) until very little field remains in the part.

For more information see chapter 17, "Principles of Magnetic Particle Testing."

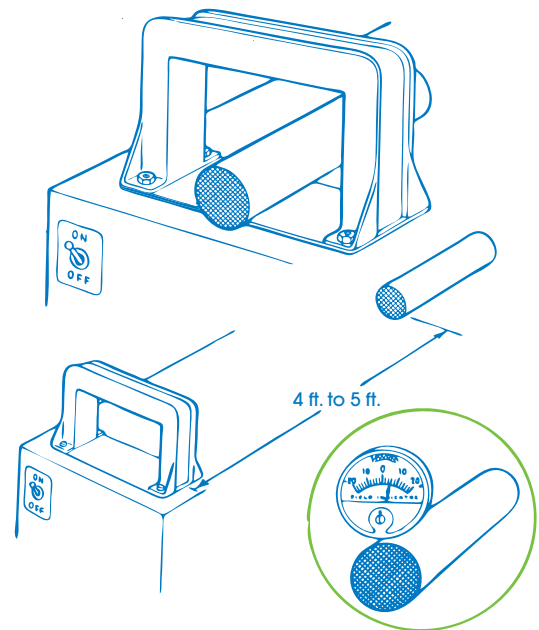

Portable Power Packs

For Magnetic Particle Testing to Find Defects in Magnetic Parts

Magnaflux offers two (2) types of portable power packs: the P-70 which puts out 750 amps, and the P-1500 which puts out 1,500 amps. However, portable equipment is available in a variety of sizes and input voltages and amperage outputs.

Portable equipment makes testing in inaccessible areas possible. The main difference between stationary equipment and portable equipment, besides the lower amperage rating, is the omission of the step-down transformer used for demagnetization. This does not limit the use of the equipment since the demagnetization still can be accomplished by manually decreasing the current or the number of cable windings can be reduced by one.

How Magnetic Particle Inspection Works Using Circular Magnetization

How Magnaflux® Uses Electricity to Create Circular Magnetic Field in the Part.

1. High amperage, low voltage current through a wire creates a magnetic field around the wire. Direction of the field is at 90° to the direction of the current.

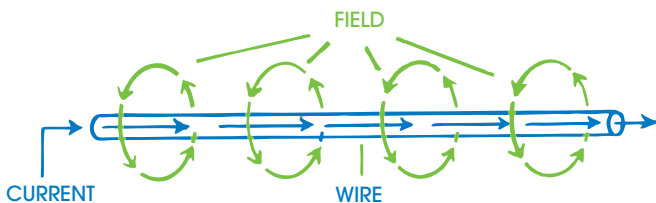

2. High amperage, low voltage current passing through a part creates a magnetic field within the part between prods. This is circular magnetization—used to detect defects parallel to current flow.

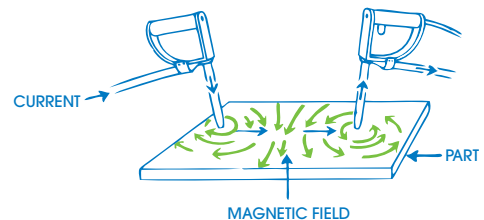

3. When performing magnetic particle inspection, circular magnetization is used to detect cracks in welds or local areas of large surfaces, heavy castings, forgings, etc.

High amperage, low voltage current is passed through the part or an area of the part between the prods or clamps held firmly to the surface. Any crack which cuts across the magnetic field attracts the magnetic particles to form an indication.

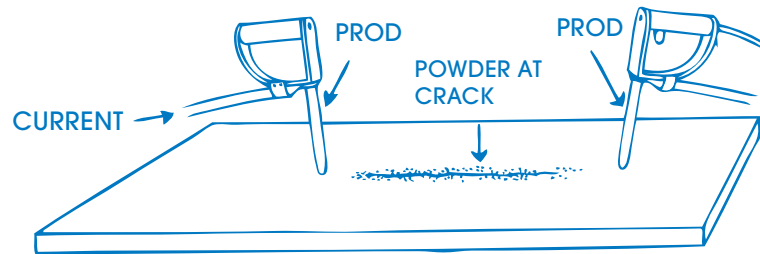

MAGNETIC PARTICLE INDICATION OF CRACK IN WELD OR CASTING WALL

High amperage, low voltage current is passed through the part parallel to the defects to be found.

For full information, refer to "Principle of Magnetic Particle Testing."

How Magnetic Particle Inspection Works Using Longitudinal Magnetization

How Magnaflux® Uses Electricity to Create a Longitudinal Magnetic Field in the Part.

1. High amperage, low voltage current passing through a wire wound into a coil creates a magnetic field lengthwise inside the coil.

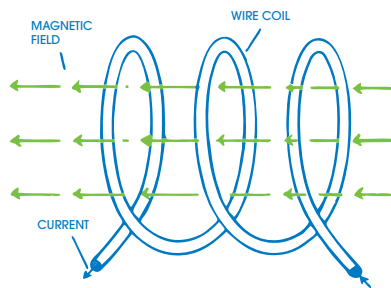

2. When a part is placed in a coil carrying high amperage, low voltage current, a magnetic field running lengthwise of the part is created. This is longitudinal magnetization.

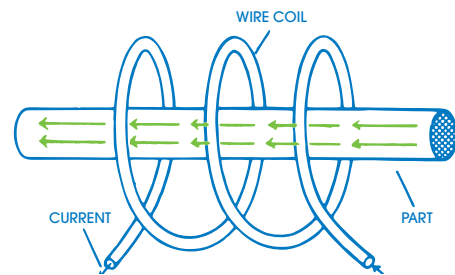

3. In inspection with magnetic particle longitudinal magnetization is used to detect transverse (crosswise) cracks.

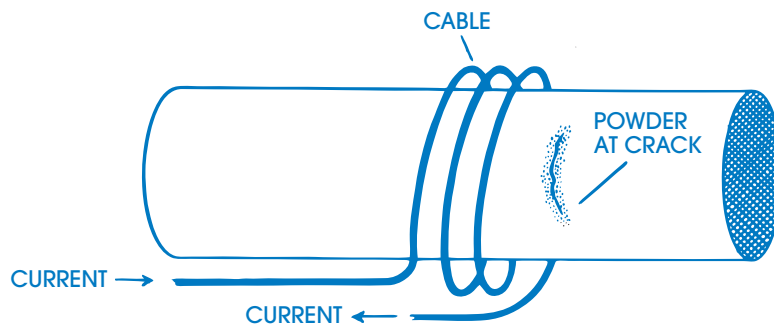

High amperage, low voltage current is passed through a coil or cable wrapped around the part. Coil should be wound to fit the part size closely and turns should be close to each other. A crack which cuts across the magnetic field attracts the magnetic particles to form an indication which may indicate a defect.

Current is passed around the part parallel to the defects to be found.

For full information, refer to "Principle of Magnetic Particle Testing."



How Magnetic Particle Inspection Works

Applying The Magnetic Particles

First, apply current.



MagnaVis® dry powder must be dusted lightly and gently to the magnetized area. Watch for indications to form as the powder is applied.

Gently blow off the excess powder, while the magnetizing current is still flowing.

MagnaVis® magnetic particle powder is available in four colors: red, black, yellow, and grey. Select the powder which gives the best color contrast with the part being inspected.

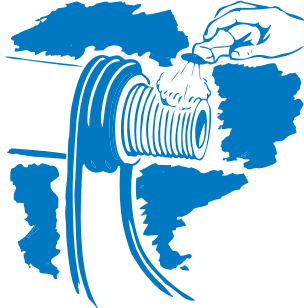

If the Magnaflux® Powder Blower is used, it applies the powder in a gentle cloud and also has a low pressure air stream to blow off excess powder. Powder may also be applied by using powder spray bulbs or disposable plastic squeeze bottles.

A liquid suspension of fluorescent or non-fluorescent magnetic particles may be used instead of dry powder. Premixed baths of either type particles are available in aerosol or in bulk for application by portable applicator guns or in pressured spray cans.



If a wet bath is used with cable magnetizing, be sure to follow agitation instructions for the inspection medium.

Weld Inspection

1. Firmly hold prods along weld, spaced from 4 to 8 inches apart and straddling the weld.
2. By turning on the magnetizing current, the area of the weld between the prods becomes magnetized.
3. While the current is flowing, lightly dust powder over the magnetized area. Watch for indications to form.
4. Gently blow off excess powder.
5. Stop current flow and look for indications.
6. Move prod tips along the weld (see diagram below) repeating all steps. Be sure that each spacing overlaps the previous shot.

Moving along the weld in this manner should bring out any cracks in the weld or along its edges which are parallel to the weld.

Be sure to:

1. Press prods firmly to the surface to prevent arcing.
2. Keep the current flowing until the excess powder has been blown off.
3. Overlap the areas inspected.
4. Reduce field strength if particles accumulate excessively at prod points.
5. Increase the field strength if there isn't some noticeable magnetic influence of the particles at the prod tips.

Field strength can be increased by increasing the strength of the magnetizing current or reducing the distance between prods.

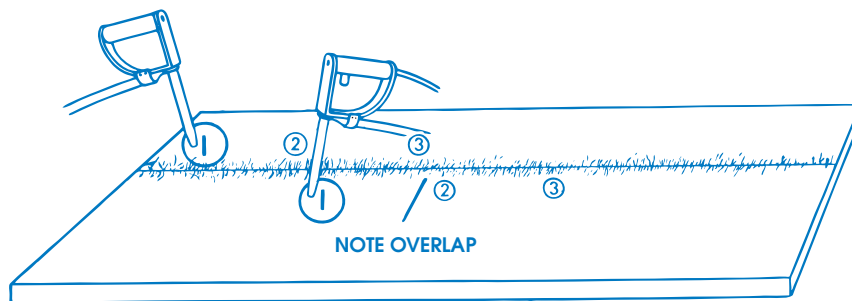

WELD INSPECTION SHOWING OVERLAP OF SHOTS NECESSARY FOR COMPLETE TEST

Inspecting Large Areas

The inspection of a large area is accomplished by inspecting many smaller areas in sequence.

With the prods spaced 8" apart, an oval shaped magnetic field will be created for adequate inspection. The magnetized area will be about 4" wide. To completely inspect a large area for cracks in one direction prod spacing will look like this:

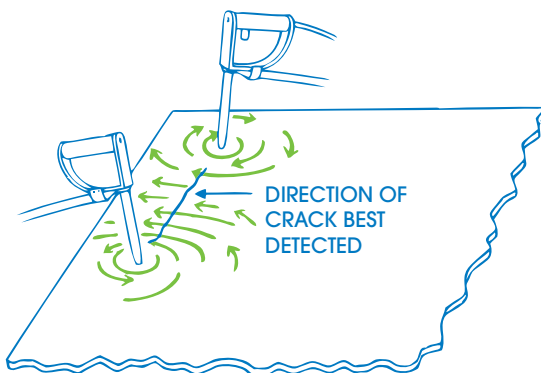

For complete inspection the entire area will have to be covered in this manner and then the process must be repeated with prod positions at 90° to the first direction.

Follow the six operations shown on page 16 for every prod spacing.

Critical areas such as change of section in complicated casting or fabrications should be inspected before finishing operations are performed. Then repairs can be made more easily. The direction of the magnetic field should be at right angles to the crack for best detection.

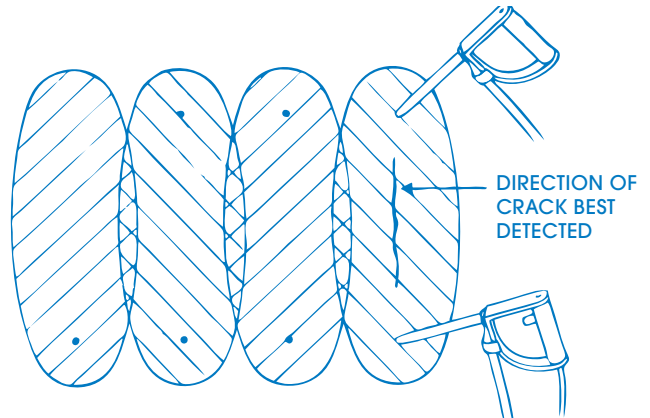

Using Cable Coils

To look for transverse (crosswise) cracks in shaft or pipe.

1. Wrap 3 to 4 turns of cable loosely around part keeping each turn close together.
2. Turn on magnetizing current.
3. While current is flowing, lightly dust MagnaVis® powder onto the magnetized area. Watch for indications to form.
4. Gently blow off excess powder.
5. Stop current flow and examine surface for indications.

Such cable wrapping usually will create an effective magnetic field from 6" to 8" on either side of the coil. If the part is long you will have to move the cable along from the first position and repeat the 5 steps of magnetization and powder application until the whole length of the part is covered.

To Inspect Hollow Parts

1. Thread 3 to 4 turns of cable through eye of part keeping turns close to each other and to the part.
2. Turn on magnetizing current.
3. While current is flowing, lightly dust powder to the magnetized area. Watch for indications to form.
4. Gently blow off excess powder.
5. Stop current flow and examine surface for indications. Move cable around the opening to examine area which was under the cable in the first operation. Repeat all 5 inspections steps above.

Demagnetization

Use AC Current For Demagnetization

1. Make a 3 to 4 turn coil loosely around the part.
2. Energize the coil.
3. Remove the coil from the part, or the part from the coil, at a distance of at least three feet.
4. Turn off the current.

Caution: Do not turn off the current until the part is out of the magnetic influence of the coil or demagnetization will not be complete.

The coil should be energized with a current as strong or stronger than that used for magnetization.

Prepared by



www.magnaflux.com